

Arola

Colección Collection



Características Técnicas

- Cartucho cerámico monomando Ø25mm en Lavabo.
- Cartucho progresivo Ø35mm en Lavabo cascada, Bidet y Lavabo alto.
- Cartucho termostático con Sistema Hot Block de seguridad antiquemaduras y Sistema Termostop de bloqueo de la temperatura a 38°C.
- Caudal a 3 bar: Lavabo. Lavabo alto y Fregadero (9 l/min). Ducha (12 l/min). Baño (20 l/min).
- Nivel acústico a 3 bar < 20 dB.
- Latón: 15 micras de espesor de níquel, 0,3 micras de cromo.
- Presión de uso entre 1-5 bar, recomendada 3 bar. Resiste presiones estáticas ≤ 10 bar y golpes de ariete de 25 bar.
- Temperatura recomendada de agua caliente 55°C. Temperatura máxima de uso 65°C. Máximo 1h a 90°C.
- Resistente al choque térmico y químico anti-legionela.
- Salida de agua cascada caudal limitado.
- Cooltouch, sistema que permite mantener la grifería templada al tacto para evitar quemaduras.

Technical Characteristics

- Ø25mm ceramic mixer tap cartridge.
- Ø35mm progressive cartridge for cascade taps, bidets and tall taps.
- Thermostatic cartridge with the Hot Block anti-burn system and the Termostop temperature blocking system (to 38°C).
- Flow rate at 3 bars: Washbasin; Tall tap and Sink (9 l/min.); Shower (12 l/min.) and Bath (20 l/min.).
- Acoustic level at 3 bars: < 20 dB.
- Plated brass: 15 microns thick of nickel, 0.3 microns of.
- Working pressure between 1-5 bars, recommended: 3 bars. It resists static pressures 10 bars and water hammers of 25 bars.
- Recommended temperature for the hot water: 55°C. Maximum working temperature: 65°C. Maximum: 1h at 90°C.
- Resistant to thermal and anti-Legionella chemical shocks.
- Cascade water outlet limited flow.
- Cooltouch, a system that keeps the faucet warm to the touch to avoid burns.

Acabados disponibles Finishing availables



● Cromo
Chrome



● Negro mate
Black matte





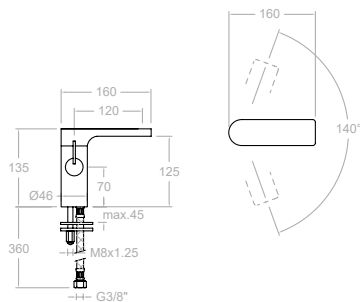

2602
261777

Monomando de lavabo con caño giratorio y aireador.
Washbasin single lever mixer with swivel spout and aerator.



Cartucho Cartridge: 25000

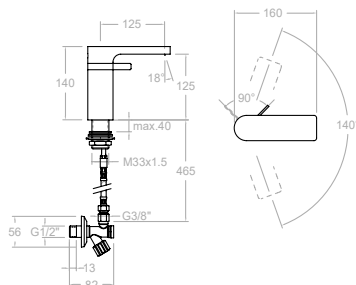

2601
226428

2601NM
26A302582

Monomando de lavabo con salida cascada, caño giratorio y cartucho progresivo de apertura en agua fría.
Washbasin mixer, swivel spout and progressive cartridge with cold opening.



3794*
AAZ301450

Llave de paso con filtro.
Stopcock with filter.

* INCLUIDA 3794 (x2).
* INCLUDED 3794 (x2)

Cartucho progresivo Progressive cartridge: 2600-P

Recomendaciones Recommendations



1219L
197106

1219LNM
99Z302477

Válvula metálica para desagüe sistema CLICK CLACK-Latón.
Metal CLICK CLACK waste brass valve.

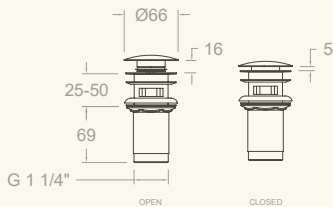

3790
198960

3790NM
99Z302332

Sifón
Bottletrap

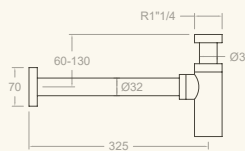

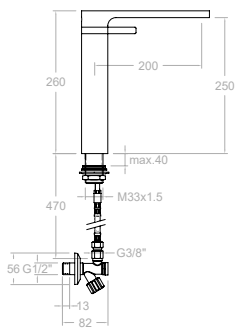

2610

229164

2610NM

26A302584

Monomando de lavabo (L) con aireador, caño giratorio y cartucho progresivo de apertura en agua fría.

Tall washbasin mixer, swivel spout and progressive cartridge with cold opening.



3794*

AAZ301450

Llave de paso con filtro.

Stopcock with filter.

* INCLUIDA 3794 (x2).

* INCLUDED 3794 (x2)

Cartucho progresivo Progressive cartridge: 2600-P

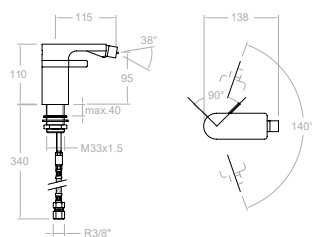

2603

226437

2603NM

26B302583

Monomando de bidé con salida de agua orientable y cartucho progresivo de apertura en agua fría.

Bidet mixer, swivel spout and progressive cartridge with cold opening.

Cartucho progresivo Progressive cartridge: 2600-P



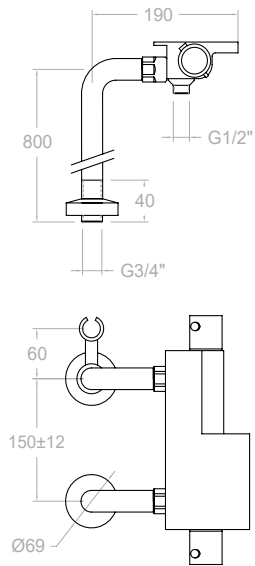

2635S
226509

Termostático de baño-ducha con salida cascada sobre columna.
Thermostatic bath-shower mixer, high column with waterfall outlet, without shower set.

2635MK
259017

Termostático de baño-ducha con salida cascada sobre columna con equipo de ducha.
Thermostatic bath-shower mixer, high column with waterfall outlet and complete shower set.



Cartucho Cartridge: 1700T + 4000

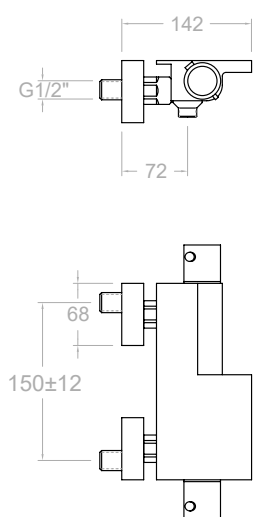

2639S
226536

2639SNM
26C302586

Termostático de baño-ducha con salida cascada.
Thermostatic bath-shower mixer with waterfall outlet.



Cartucho Cartridge: 1700T + 4000



MK

2639MK

258891

2639 S+4713MK+4726M+2471C



2639KNM

26C302585

2639SNM+4714KNM+472602NM+2475CNM



Termostático de baño- ducha salida cascada con equipo de ducha.

Thermostatic bath-shower mixer, with waterfall outlet, and shower set.

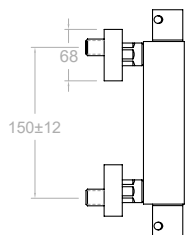
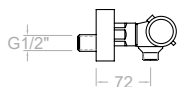

263402S

261873



263402SNM

261875



Termostático de ducha.

Thermostatic shower mixer without shower kit.



Cartucho Cartridge:1701T + 1700C1/2



MK

263402MK

261876

263402 S+4713MK+4726M+2471C



263402KNM

261878

263402SNM+4714KNM+472602NM+2475CNM



Termostático de ducha.

Thermostatic shower mixer without shower kit.



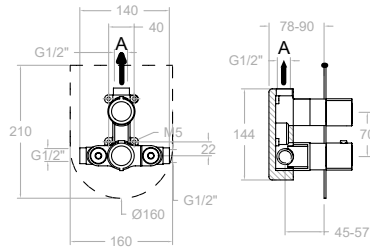

262411S
26D302529

262411SNM
26D304973

Termostático de ducha empotrado metálico 1 vía con placa ultraslim.
Thermostatic concealed shower 1 way with ultraslim plate.

XX2411	1bar	3bar	5bar
A l/min	17	26	31
Kit de ampliación - Extension set: KAETDI04			



1 Vía/Way

Cartucho Cartridge: 1703T + 1700C3/4"

XX2411+KTU1+265000+265100

XX2411NM+KTU1NM+265000NM+265100NM

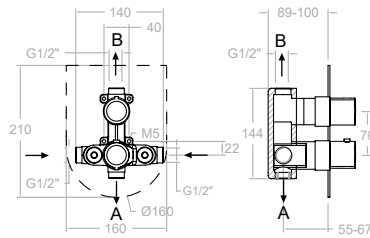

268712S
26D302538

268712SNM
26D304974

Termostático de baño-ducha empotrado metálico 2 vías con placa ultraslim.
Thermostatic concealed shower 2 ways.

XX8712S	1bar	3bar	5bar
A l/min	17	26	31
B l/min	13	22	28
Kit de ampliación - Extension set: KAETDI03			



2 Vías/Ways

Cartucho Cartridge: 1703T + 4000

XX8712+KTU2+265000+265100

XX8712NM+KTU2NM+265000NM+265100NM

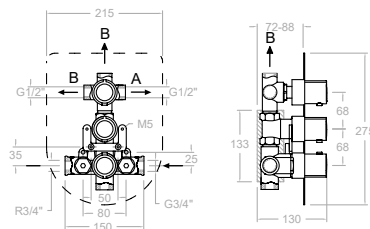

2627S
229533

Termostático de baño-ducha empotrado metálico 3 vías con placa ultraslim.
Thermostatic concealed bathshower mixer 3 ways with ultraslim plate.

XX8712S	CARTUCHO GRAN CAUDAL 1700 TE		
	1bar	3bar	5bar
A	13,5	23,3	30,2
B	9,3	15,5	19,2
Kit de ampliación - Extension set: KAETDI			



3 Vías/Ways

Cartucho Cartridge: 1700TE + 1700C3/4 + 1000I

ETDI+KL23+2651+2655+2653

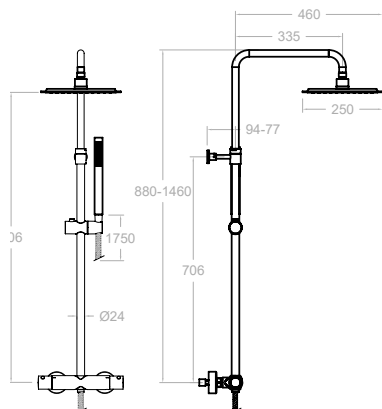

265403RK250

26D303718

265403RK250NM

26D304975

Columna de ducha telescópica termostática rociador metálico cuadrado 250mm.

Thermostatic shower column with telescopic bar.



261203S

26D303731

261203SNM

26D304977

Termostático de columna.

Thermostatic shower.

Cartucho Cartridge: 1703T + 4000

261203S+DN130D+RK250+4713MK+2471C

261203SNM+DN130DNM+RK250NM+4714KNM+2475CNM

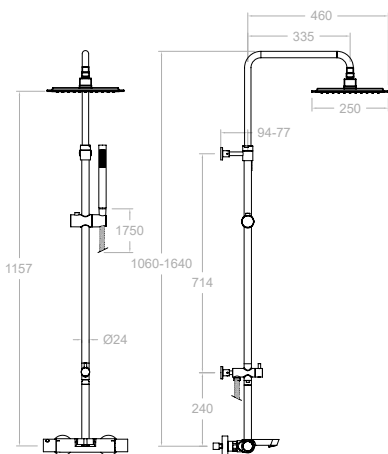

265602RK250

26C303798

265602RK250NM

26C304976

Columna de baño-ducha telescópica termostática rociador metálico cuadrado 250 mm.

Thermostatic bath-shower column with telescopic bar.



264612S

26C303808

264612SNM

26C304978

Termostático de baño-ducha.

Thermostatic bath-shower mixer

Cartucho Cartridge: 1701T + 4000

264612S+DN130D+T18+IPD16+RK250+4716PR+2471C

264612SNM+DN130DNM+T18NM+IPD16NM+RK250NM+4714KNM+2475CNM

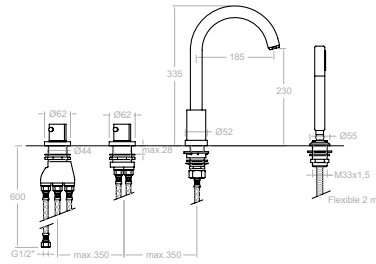

263303TM
26C301649

Termostático de repisa para bañera con equipo de ducha metálico.
Deck mounted thermostatic bathub set with shower kit.

Cartucho Cartridge: 1700 TE + 4000
T2633+D2633+3713M+9989SC+C623302+2850C

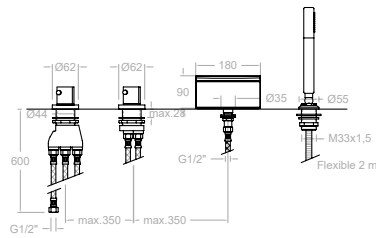

263304TM
26C302909

Termostático de repisa para bañera con caño cascada y equipo de ducha metálico.
Deck mounted thermostatic bathub set with waterfall and shower kit.

Cartucho Cartridge: 1700 TE + 4000
T2633+D2633+3713M+9989SC+CR01+2850C

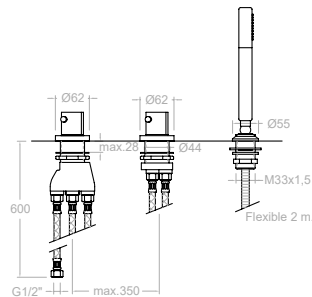

2633TSCAM
255867

Termostático de repisa para bañera sin caño y con equipo de ducha metálico.
Deck mounted thermostatic bathtub with shower kit, without bath spout.

Cartucho Cartridge: 1700 TE + 4000
T2633+D2633+3713M+9989SC+2850C



Recomendaciones Recommendations

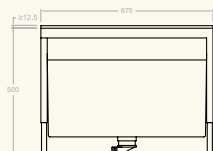

100502
AAZ302174

Repisa extraíble con depósito para el agua de conjunto baño.
Mounting block with height adjustable panel and tube box for bath deck (included).

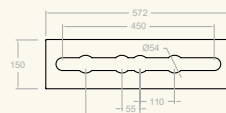

100502R
AAZ302626

Repisa soporte para conjunto baño.
Mounting plate for bath deck.

Arola